









# 100cm Majestic Electric Oven & 6 Zone Ceramic Cooktop

## MDE100MP



-  **MADE IN ITALY**
-  **24 MONTH WARRANTY**
-  **100CM WIDE**
-  **EXPERT MODE**
-  **COOL TOUCH**
-  **1,625 RAL COLOURS**  
\* consult with ILVE
-  **88.88°C**  
**DIGITAL DISPLAY**
-  **10 MULTI-FUNCTION MODES**  
\* Main oven ONLY
-  **5 COOKING LEVELS**



A true kitchen centerpiece that is sure to demand attention. Featuring the same cook top options as the ILVE Quadra range, these exceptional cookers will compliment any kitchen and its cook.

While a highlight of the Majestic range is its 700mm depth, the standard functions you expect from ILVE, including the electric rotisserie, precision thermostatic control, concealed grill element, programmable timer and turbo wave cooking feature, not to mention the digital food monitor - have not been forgotten.

The unique style of the Majestic Freestanding Ovens stands out above the rest and to enhance this, ILVE offers the ability to create a customized and individual look. Choose between the traditional (Majestic) or contemporary (Majestic Techno) style; pick one of six colours with brass, chrome or bronze fittings; and select from five available sizes (70cm, 90cm, 100cm, 120cm and 150cm). Also available are matching range hoods with infrared heat lamps (AM series).

Never ceasing to disappoint, ILVE is bringing incomparable design, choice and functionality to the everyday Australian kitchen.

### Fitting



Majestic Knobs and Handles in Brass



Majestic Knobs and Handles in Chrome (X)



Majestic Knobs and Handles in Bronze (Y)

### Colour Palette



Bright White



Stainless Steel



Antique White



Blue



Matt Black



Emerald Green



Burgundy

# 100cm Majestic Electric Oven & 6 Zone Ceramic Cooktop

## MDE100MP



### Model MDE100MP

#### Electric Oven

- Double Electric Oven: Select 10+5 multifunction cooking modes
- 70 litre oven capacity oven 1
- 40 litre oven capacity oven 2
- Roast Probe (digital food monitor in Main Oven Only)
- Easy dismantling of oven interior
- Easy clean vitreous enamel interior smooth black non staining appearance
- Recessed full width grill element (Both Ovens)
- Rotisserie (30cm oven only)
- Electronic programmable timer
- Cool touch athermic door handle
- Control panel and door cooling fan
- Triple door glazing for safer, cooler door temperatures
- Catalytic self cleaning system (Main Oven Only)
- Stainless steel fan fat filter (Main Oven Only)
- Removable oven door and inner door glass
- Storage and warming drawer
- Turbowave cooking, lower temperatures, less food spatter, moister fresher tasting roasts
- Pizza and bread mode (Main Oven Only)
- Precision thermostatic control 0°C through to 250°C
- Quickstart fast preheat time 0°C – 175°C in 6 minutes (Main Oven Only)

 For installation specifications, please consult with ILVE. For optimum installation, we recommend using the actual product as the best guide.

#### Ceran Cooktop

- 100cm Electric ceran cooktop
- Six highlight instant heat electric elements
- Marker heat zone cooking
- Precision thermostat control
- Regional heat warning light
- Full sealed hob to bench protective
- Low profile 50mm deep
- Triple, dual zone heat elements

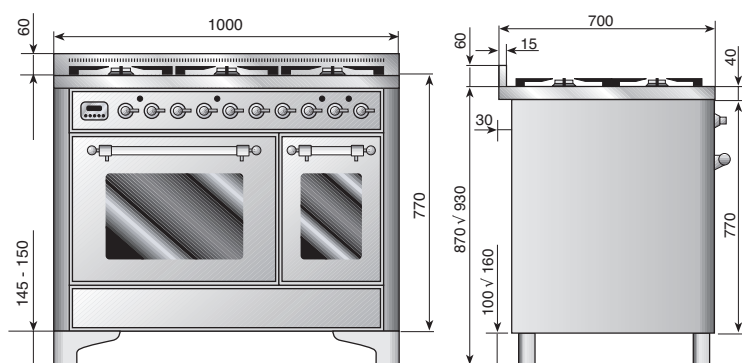

**100cm Majestic 6 Zone Model MDE100MP**  
Total Electrical Load (Kw) 17.5



18112016

Australia National Telephone Number 1300 MYILVE (694 583) New Zealand Telephone Number 0508 458 369  
ILVE showrooms are open Tuesday - Friday from 9am-5pm and Saturdays 10am-4pm. CLOSED Monday & Sunday

[ilve.com.au](http://ilve.com.au)

#### NSW & ACT (Head Office)

48-50 Moore Street  
Leichhardt  
F 02 8569 4699

#### VIC & SA

1211 Toorak Road  
Camberwell  
F 03 9809 2155

#### QLD

1/42 Cavendish Road  
Coorparoo  
F 07 3397 0850

#### WA & NT

Unit 10/55 Howe Street  
Osborne Park  
F 08 9201 9188

#### TAS (Crisp Ikin)

3 Pear Avenue  
Derwent Park, 7009  
P 03 6272 7386

#### New Zealand

PO Box 11.160  
Sockburn Christchurch  
F 03 344 5906

#### DISCLAIMER

Eurolinx PTY LTD, trading as ILVE Appliances, is continually seeking ways to improve the design specifications, aesthetics and production techniques of its products. As a result alterations to our products and designs take place continually. Whilst every effort is made to produce information and literature that is up to date, this brochure should not be regarded as an infallible guide to the current specifications, nor does it constitute an offer for the sale of any particular product. Product dimensions indicated in our literature is indicative only. Actual product only should be used to define dimension cutouts. Distributors, and retailers are not agents of ILVE Appliances and are not authorized to bind ILVE Appliances by any express or implied undertaking or representation.