











120cm Double Electric Ovens & 7 Burner Cooktop

PW1207MP



- 
MADE IN ITALY
- 
24 MONTH WARRANTY
- 
120CM WIDE
- 
EXPERT MODE
- 
COOL TOUCH
- 
1,625 RAL COLOURS
* consult with ILVE
- 
88:88^{mm} DIGITAL DISPLAY
- 
11 MULTI-FUNCTION MODES
* Main Oven Only
- 
BRASS BURNER
- 
5 COOKING LEVELS



Ingeniously combining the latest cook top technology with ILVE's peerless upright ovens, you'll find yourself at a gastro level in no time at all. Italian design and the superior quality synonymous with all ILVE products ensure this is no ordinary kitchen appliance.

Choose from up to 6 different cooking surfaces including ILVE's famous Tepanyaki plate and available in Stainless Steel, Gloss Black and Bright White not to mention sizes ranging from 60cm, 70cm, 80cm, 90cm, 100cm, 120cm and 150cm with some styles available with double ovens, versatility is not hard to find.

ILVE's pioneering freestanding ovens incorporate chef quality features that will delight any aspiring home chef or want-to-be kitchen master. Culinary heights once thought unobtainable are now within reach with features such as the pizza and bread cooking function, rotisserie and new improved precision thermostatic technology boosters, scorching from 0-250°C in an instant.

ILVE's Upright oven's even include a Catalytic cook and clean side liners interior, triple door glazing for safer, cooler door temperatures and a cool touch athermic door handle.

Functionally simple to use and a breeze to cook with, ILVE is truly the next generation in cooking.



Pictured: ILVE Brass Burner

Colour Palette



Bright White



Stainless Steel



Gloss Black

120cm Double Electric Ovens & 7 Burner Cooktop

PW1207MP



Model PW120-7MP

Electric Oven

- Two Electric Ovens: Select 11+5 multifunction cooking modes
- 110 litre oven capacity oven 1
- 40 litre oven capacity oven 2
- Easy clean vitreous enamel interior finished in smooth black
- Electric Rotisserie in both Ovens
- AS304 stainless steel commercial style control panel and knobs
- Dual Recessed full width grill element
- Digital programmable timer (main oven ONLY)
- Control panel and door cooling fan
- Triple glazed glass door for safer, cooler door temperatures
- Catalytic self cleaning system (main oven ONLY)
- Positive stop glide internal trays
- Large baking trays
- Stainless steel fan fat filter (main oven ONLY)
- Removable oven door and inner door glass
- Storage drawer
- Sealed oven: lower temperatures, less food spatter, moister fresher tasting roasts
- Precisionthermostaticcontrol 0°C–250°C
- New Turbowave Quickstart preheating function 0°C –175°C in 8 minutes (main oven ONLY)

Gas Cooktop

- 120cm gas cooktop
- Large cooking surface with spacious burner layout
- Two Triple ring solid brass WOK burner (5 kW – European Tested)
- 1 small, 1 elonguated/fish and 3 Large gas burners
- Precision burner controls with accurate flame control
- Cast iron heavy duty trivets and burners in matt black finish
- All gas burners fitted with flame failure safety devices
- Deep recessed spill trays
- Easy clean removable trivets and burners
- All burners made from Solid Brass
- AS 304 Stainless Steel construction

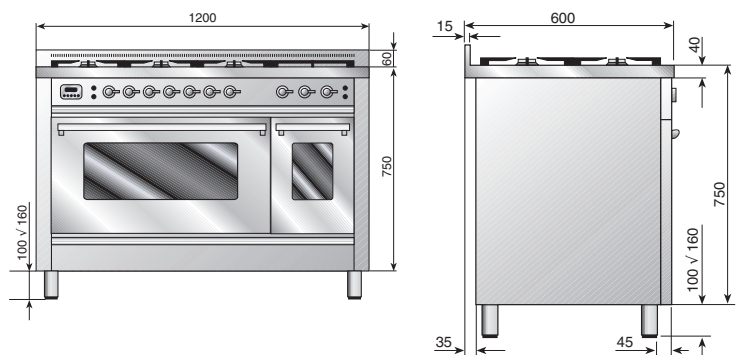

120cm Quadra 7 Burner Model PW1207MP
 Total Electrical Load (Kw) 5.7
 Total Gas 'NG' Consumption (Mj/h) 76.3

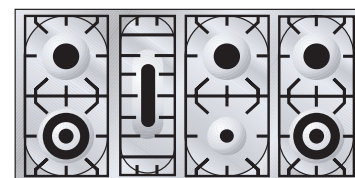

18112016

 For installation specifications, please consult with ILVE. For optimum installation, we recommend using the actual product as the best guide.

Australia National Telephone Number 1300 MYILVE (694 583) New Zealand Telephone Number 0508 458 369
 ILVE showrooms are open Tuesday - Friday from 9am-5pm and Saturdays 10am-4pm. CLOSED Monday & Sunday

ilve.com.au

NSW & ACT (Head Office)

48-50 Moore Street
 Leichhardt
 F 02 8569 4699

VIC & SA

1211 Toorak Road
 Camberwell
 F 03 9809 2155

QLD

1/42 Cavendish Road
 Coorparoo
 F 07 3397 0850

WA & NT

Unit 10/55 Howe Street
 Osborne Park
 F 08 9201 9188

TAS (Crisp Ikin)

3 Pear Avenue
 Derwent Park, 7009
 P 03 6272 7386

New Zealand

PO Box 11.160
 Sockburn Christchurch
 F 03 344 5906

DISCLAIMER

Eurolinx PTY LTD, trading as ILVE Appliances, is continually seeking ways to improve the design specifications, aesthetics and production techniques of its products. As a result alterations to our products and designs take place continually. Whilst every effort is made to produce information and literature that is up to date, this brochure should not be regarded as an infallible guide to the current specifications, nor does it constitute an offer for the sale of any particular product. Product dimensions indicated in our literature is indicative only. Actual product only should be used to define dimension cutouts. Distributors, and retailers are not agents of ILVE Appliances and are not authorized to bind ILVE Appliances by any express or implied undertaking or representation.