









60cm Built-in Pyrolytic Oven

600 SPYKT



- 
COOL TOUCH
- 
MADE IN ITALY
- 
DIGITAL DISPLAY
- 
PYROLYTIC CLEANING
- 
EXPERT MODE
- 
10 MULTI-FUNCTION MODES
- 
24 MONTH WARRANTY
- 
COOKING LEVELS
- 
60CM WIDE

ILVE's new 600 Series compact ovens are the culmination of 2 years of research and development to bring Australian homes a oven that has the technology, sophistication and appearance that embodies the ILVE brand whilst having many functional advantages over its competitors.

The new size of the cooking cavity provides more cooking space and maximises the full internal size of the oven. Our new ULTRA-Clean light grey, nickel-free enamel interior reduces the toxicity of materials in contact with foods and is easy to clean. ILVE's Tangential Ventilation System (TVS) smartly circulates air around the oven to ensure protection of your kitchen cabinets. Standard in the oven are Telescopic racks and are totally removable making the use of the ovens baking trays and general cooking in the oven easy and effortless. The Full size inner door glass provides a panoramic view from the outside of the oven door of what is inside the oven, its fill width also enables easy cleaning with no crevices for food scraps and residue to get trapped.

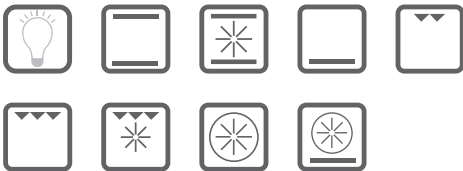

Digital thermostat



ULTRA-Clean smooth grey cavity



Laser etched cooking modes on control panel with symbol & words

60cm Built-in Pyrolytic Oven

600 SPYKT



Model 600 SPYKT

- Select 10 multifunctional expert modes
 - Light, convection, fan assisted, bottom, half grill, grill, fan grill, fan forced, pizza & self clean
- PYRO-clean mode for pyrolytic cleaning with electronic door lock
- ULTRA-Clean smooth grey cavity
- Cool touch BIO-safe quadruple glazed glass door
- PANA-view full-glass oven door and inner glass
- 77 litre oven capacity
- Dark / black tinted glass on door exterior
- Laser etched cooking modes on control panel with symbol & words
- Closed door grilling
- Knob control
- Digital thermostat
- Standard with 1 x set of telescopic runners - with 75% extraction
- 5 cooking levels
- Removable oven door and inner door glass
- Precision thermostat control
- Included accessories: 2 x Oven racks & 1 x Grill pan (baking dish) set
- Made in Italy

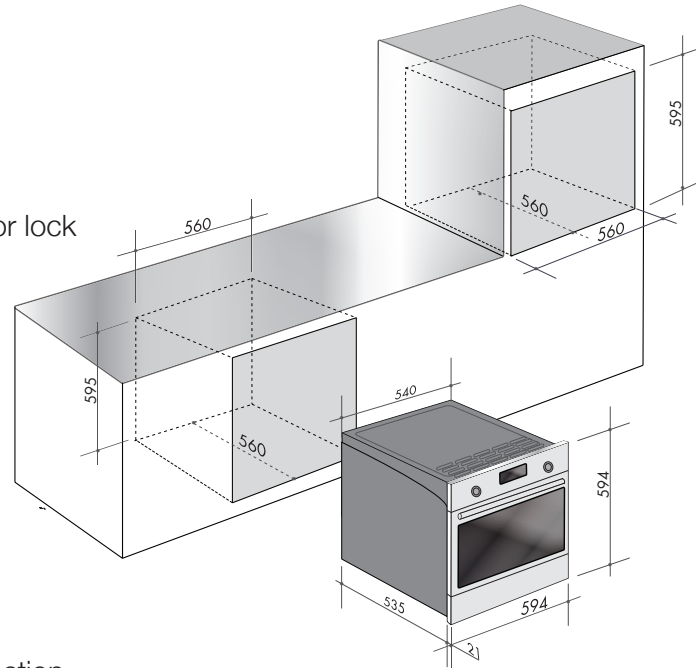

Built-in Oven 60cm
Model 600 SPYKT
Total electrical load: 3.5 kw/h

01072016

You can find us on:

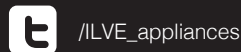

Australia National Telephone Number 1300 MYILVE (694 583) New Zealand Telephone Number 0508 458 369
ILVE showrooms are open daily from 9am-5pm and Saturdays 10am-4pm

ilve.com.au

NSW & ACT (Head Office)

48-50 Moore Street
Leichhardt
F 02 8569 4699

VIC & SA

1211 Toorak Road
Camberwell
F 03 9809 2155

QLD

1/42 Cavendish Road
Coorparoo
F 07 3397 0850

WA & NT

Unit 10/55 Howe Street
Osborne Park
F 08 9201 9188

TAS (Crisp Ikin)

3 Pear Avenue
Derwent Park, 7009
P 03 6272 7386

New Zealand

PO Box 11.160
Sockburn Christchurch
F 03 344 5906