







BENCHTOP MICROWAVE

IVFSM643X

- 
24 MONTH WARRANTY
- 
1200W GRILL
- 
DEFROST FUNCTION
- 
10 POWER LEVELS
- 
CHILD LOCK
- 
DIGITAL DISPLAY
- 
TOUCH CONTROL



Our stainless steel microwave ovens are designed to complement your choice of ILVE oven. Simple to use and made of the finest materials, with stainless steel used internally, this microwave is easily cleaned and maintained. Because microwave oven units are usually fitted to supplement the built-in oven, it is especially important that they match in design and colour. ILVE appliances are renowned for forming a perfectly integrated family of built-in appliances. That's why this microwave comes with an integrated trimkit to build in with your choice of ILVE oven.

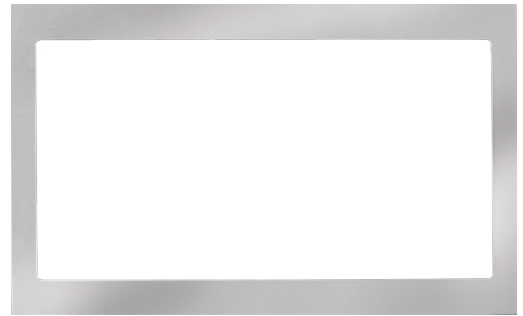

Matching trimkit IVTK34 to suit IVFSM643X microwave

Standard Option - Microwave Colour



Stainless Steel

BENCHTOP MICROWAVE

IVFSM643X

IVFSM643X BENCHTOP MICROWAVE

FEATURES

- Touch control panel
- Pull open door (handle)
- Microwave output: 1000W
- Microwave power: 1500W
- 10 power levels

CAPACITY & INTERIOR

- 34 litre capacity
- Stainless steel cavity

SAFETY

- Child lock

FUNCTIONS

- 6 one touch cook programmes
- 3 auto defrost programmes

ACCESSORIES

- Turntable
- Grill platform insert
- * Optional trimkit is also available for building into cabinetry (Model: IVTK 34)

TECHNICAL INFORMATION

- 10 amp electrical connection, plug & lead supplied
- Size: 560W x 344H x 435D + 20mm fascia

Matching trimkit IVTK34 to suit IVFSM643X microwave

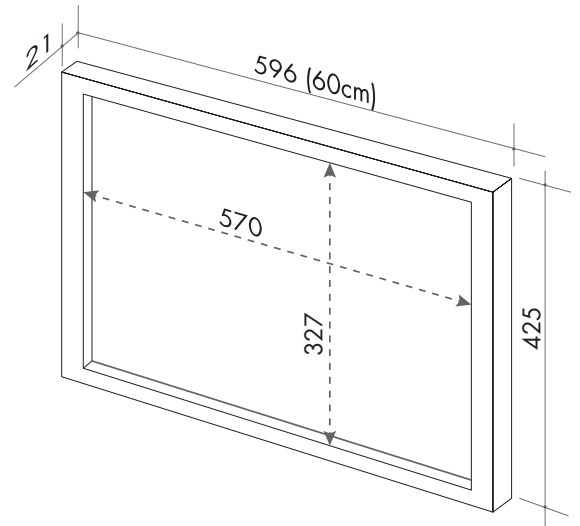

Microwave

EAN code: 9341584034274 (IVFSM643X)

Product Size: 560W x 344H x 435D + 20mm fascia

NB: drawings are not to scale — they are to be used as a guide only

FOLLOW US:



/ilve_appliances/



/ILVEappliances



/ILVE_appliances



/ILVEappliances

Page 2/2
26052021

Australia National Telephone Number 1300 MYILVE (694 583) New Zealand Telephone Number 0508 458 369
ILVE showrooms are open daily from 9am-5pm and Saturdays 10am-4pm

ilve.com.au

NSW & ACT (Head Office)

48-50 Moore Street
Leichhardt
F 02 8569 4699

QLD

1/42 Cavendish Road
Coorparoo
F 07 3397 0850

WA & NT

Unit 10/55 Howe Street
Osborne Park
F 08 9201 9188

New Zealand

PO Box 11.160
Sockburn Christchurch
F 03 344 5906

DISCLAIMER
Eurolinx PTY LTD, trading as ILVE Appliances, is continually seeking ways to improve the design specifications, aesthetics and production techniques of its products. As a result alterations to our products and designs take place continually. Whilst every effort is made to produce information and literature that is up to date, this brochure should not be regarded as an infallible guide to the current specifications, nor does it constitute an offer for the sale of any particular product. Product dimensions indicated in our literature is indicative only. Actual product only should be used to define dimension cutouts. Distributors, and retailers are not agents of ILVE Appliances and are not authorized to bind ILVE Appliances by any express or implied undertaking or representation.